

THE PROPERTY OF THE DRAWING IS ESTABLISHED BY LAW. IT IS FORBIDDEN TO PRODUCE OR SHOW IT TO THIRD PARTY, WITHOUT A WRITTEN AGREEMENT.

Item	Name	Q.ty
1	APGE.20.20.50	1
2	R.5.SCH	2
3	V.TCE5x12	2

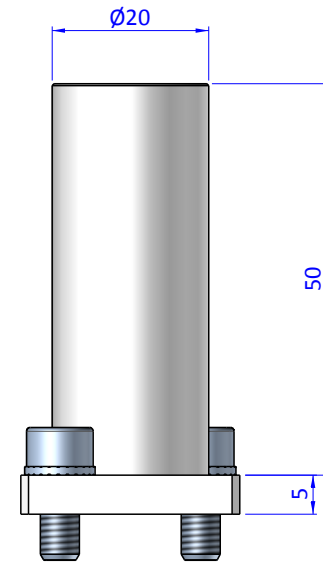
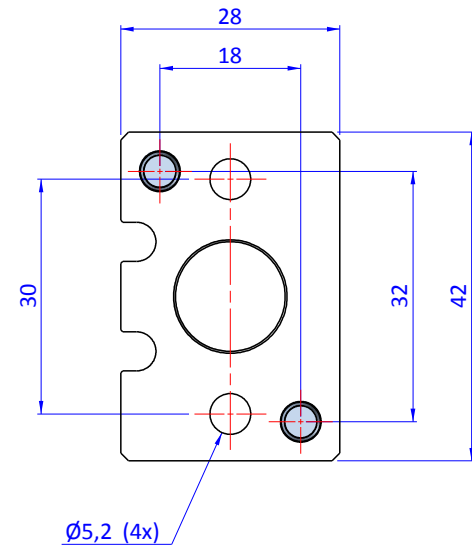
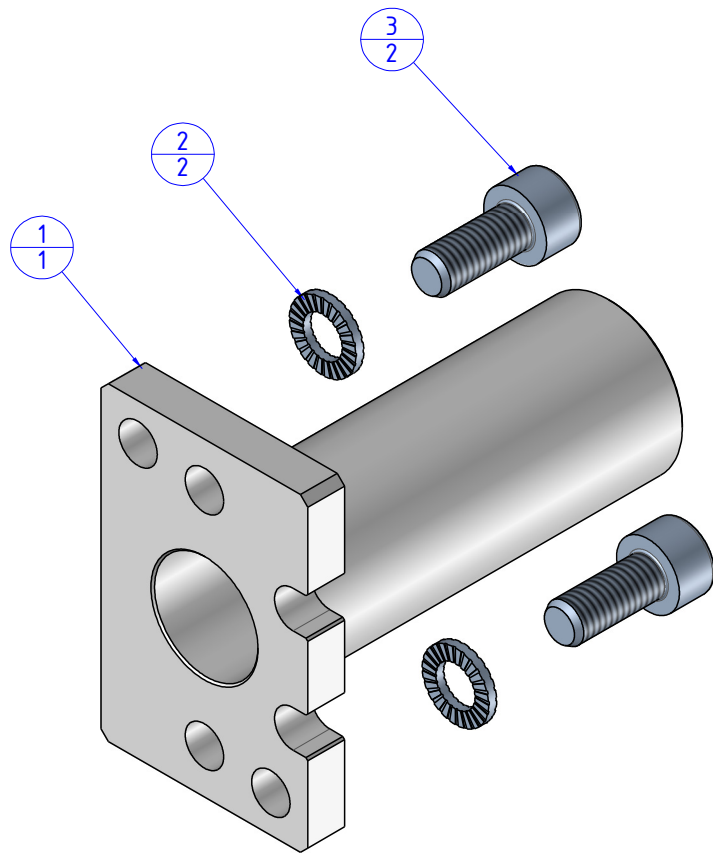

Format A3

UNI 936-76

		DESIGNED FROM		REVIEW
		FPS Automation		A
GENERAL TOLERANCE		DATE	WEIGHT	
UNI - ISO 2768		02/04/2019	0,042kg	
CLASSE f	DESCRIPTION	CODE		
	CA.APGE.20.20.50	CA.APGE.20.20.50		